



# QUICK RELEASE SET - 5 PUNTS

## inhoud



2 x blus70

 Bandje met lus 70 cm

 Strap with loop 70 centimeters



2 x ring206

Ring

Ring



2 x drkn6

Draaiknop

Rotary knob

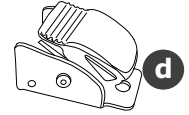

1 x hlmgsp

Metalen gesp

Metal buckle



3 x stkgspm25

 Steekgesp "deel 1"

 Buckle "part 1"



2 x stkgspv25

Steekgesp "deel 2"

Buckle "part 2"

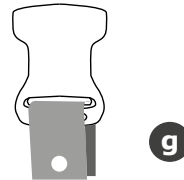

1 x bmg10stkgspv25

Steekgesp met bandje en ring

Buckle with strap and ring



5 x schgsp25

Kunststof schuif gesp

Plastic buckle



2 x bmg60

 Lang bandje met gat

 Long strap with hole



1 x b20

Kort bandje

Short strap

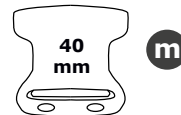

2 x stkgspv40

Steekgesp breed "deel 1"

Width buckle " part 1"

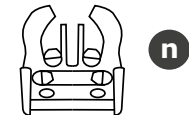

2 x stkgspm40

Steekgesp breed "deel 2"

Width buckle " part 2"

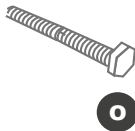

2 x bout306

 Bout

 Bolt



1 x schroef84moer

schroefje en moertje

srew and nut

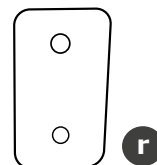

1 x drkn6

plaatje

metal plate

## gordels monteren in uw stoel



Voordat u verder kunt gaan met het monteren uw set voor 5 punts modellen, dient u eerst uw MELIA stoel met 5 puntsgordel te assembleren tot één geheel. U heeft bij ontvangst ook handleidingen ontvangen. Hieronder tonen wij die nogmaals om u op weg te helpen. Scan de barcode voor de instructie-video.



Before you continue with the installing your mountingset for 5 point in your MELIA seat you should install the safetybelt for children first. After your purchase you'll find enclosed the quick user manual with the product. Below is a reminder how to install to get you started.



scan for video instruction



How to fix the 5 point safetybelt in MELIA seat part 1 of 3



scan for video instruction



How to fix the 5 point safetybelt in MELIA seat part 2 of 3



scan for video instruction



How to fix the 5 point safetybelt in MELIA seat part 3 of 3

scan for video instruction



All about fixing the metal plate at the back of the seat

## wel of geen gat boren in het hout?

! requirements to use this set - vereisten om deze bevestigingsset te kunnen gebruiken.

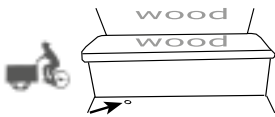

Bakfiets met een houten bak of een bakfiets met een houten zitbankje. Dit setje is ook van toepassing als u opbergruimte heeft onder het bankje



Cargobike with wooden box of with a wooden bench. If you have a storage under the bench you need this set.

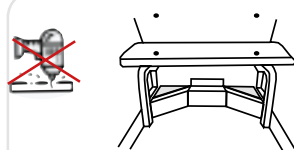

Als u de meegeleverde gordels van uw bakfiets verwijderd heeft u een gat in de bak en/of in het bankje. U hoeft niet te boren.



When removing the cargobike belts a hole will appear in the woodenbox and/or in the bench. No drilling needed.

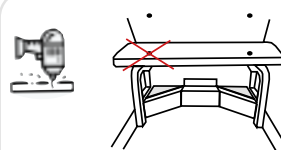

Als u de meegeleverde gordels van uw bakfiets verwijderd heeft u een **GEEN** gat in de bak en/of in het bankje. U dient een gat te boren van 6 mm ø



When removing the cargobike belts **NO** hole will appear in the woodenbox and/or in the bench. Drilling needed. Use a 6 mm ø drill.

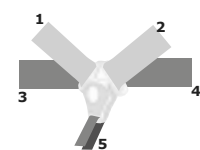

U bent in het bezit van een Melia 5-puntsmodel babyschaal of peuterstoel.



Compatible with Melia 5-point model babyshell or toddlerseat seat

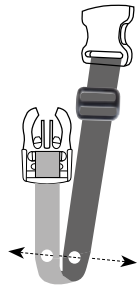
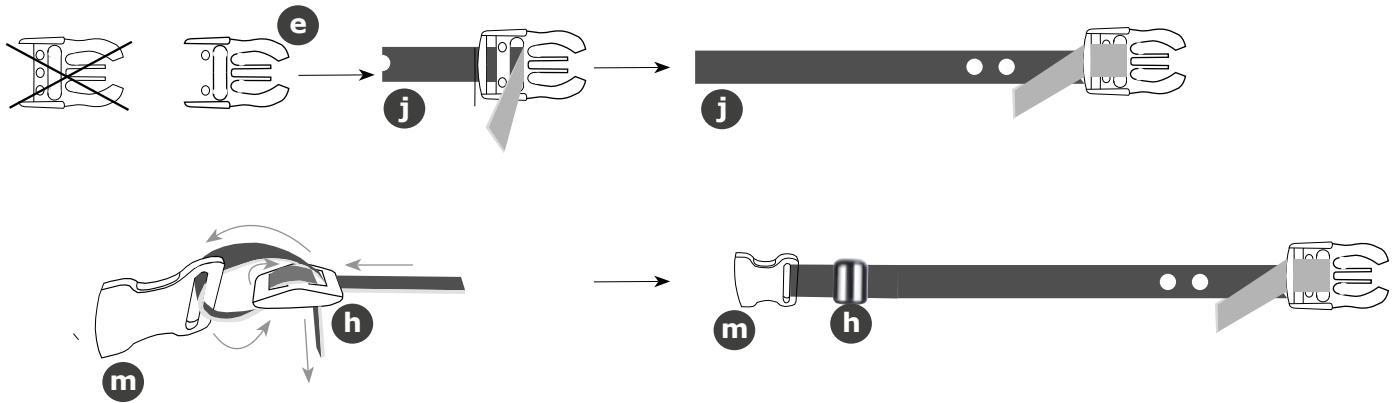

Ter voorbereiding moet u eerst onderdeel "J" en "E" samenvoegen tot één onderdeel. Zet steekgesp "deel 1" naar u toe en trek bandje "J" erdoor zoals te zien bij het voorbeeld. Als u het goed heeft gemonteerd dan kunt u het bandje er niet makkelijk meer uittrekken.



Before we start with mounting the parts on your cargobike you first have to put part "J" and "E" together. Place towards you as shown. Pull the strap "J" through the buckle. If all done properly it's not easy pulling the strap through the buckle.

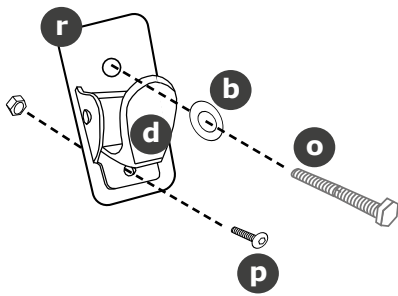

Neem nu plaatje "R" en bijbehorende schroef en moertje "P". Plaats de metalengesp "D" erop, zodat de twee kleinere gaten op elkaar komen te liggen. Steek de kleine schroef erdoor en maak vast. Steek schroef "E" door het grote gat.



Place metal buckle "D" on plate "R" the two little holes should be opposite. Push the little screw "P" through both holes and then fasten it. Push screw "O" through the larger hole.

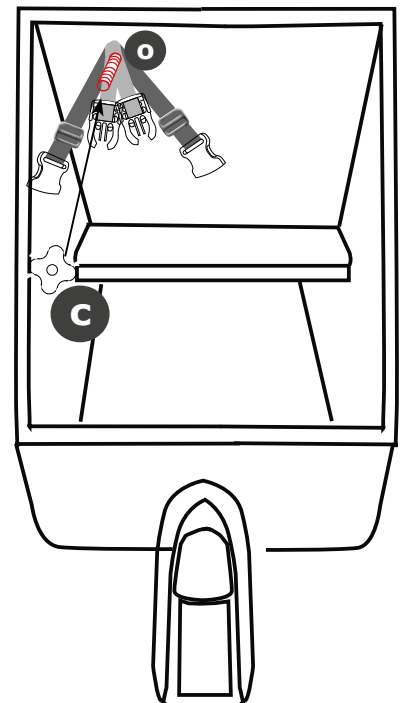
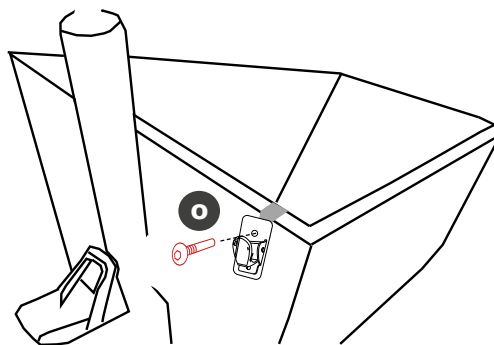
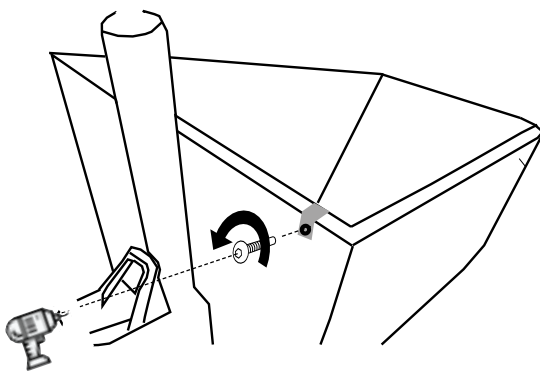

Draai de schroeven los waaraan de gordels van uw bakfiets zitten. Neem het plaatje met de metalengesp erop en plaats deze tegen de bak aan. Zorg dat de schroef "O" door het gat gaat van de bak. Deze schroef "O" steekt nu een stukje uit aan de binnenkant van uw bak. Neem het onderdeel "J" en "E" dat u al eerder had voorbereid. Plaats dit onderdeel aan de binnenkant van de bak. Zorg ervoor dat de uitstekende schroef door het gat van het bandje gaat. Draai nu de draaiknop "C" op de schroef.



Unscrew the bolt holding your original safety belt of your cargobike. There is a hole in your cargobike now. If not you should make a  $\varnothing$  6 mm hole.

Place the metal buckle and plate against it. Push screw "E" through the hole. The end of the screw will now show at the inside.

Take part "J" and "E" that you already fixed and place against the screw inside. Turn the knob "C"

## stoel vastmaken aan bak

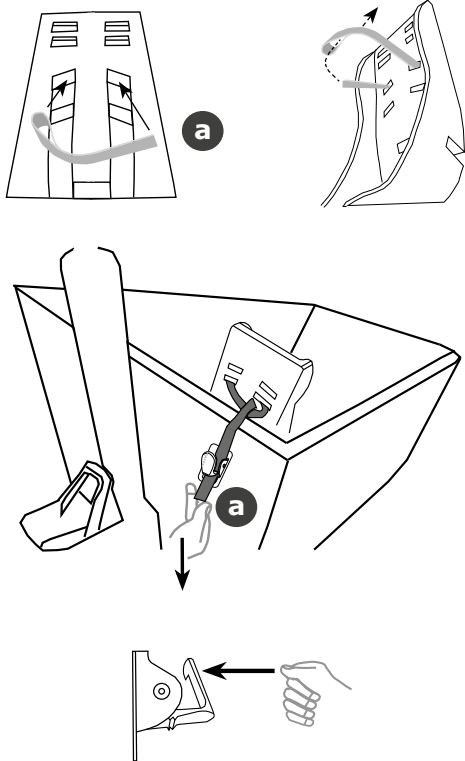

Met deze set maakt u zowel de stoel vast aan de bak, maar ook de gordels waar uw kind in zit.

Trek gordelband "A" door de MELIA stoel en daarna door de metalen klem. U kunt de gordelband maar één kant op trekken. U kunt zelf bepalen hoe strak het stoeltje zit tegen de achterkant. Indien u het iets losser wenst kunt u het stoeltje meer onderuit laten zakken. U dient dan wel de onderkant strakker te zetten. Meer info bij vastmaken onderkant.

Als u de MELIA stoel wilt losmaken drukt u op de metalen gesp. Daarna is de gordelband weer vrij en kan de stoel worden losgekoppeld



This mountingset enables you to secure the MELIA seat and the safetybelt as well.

Pull the strap "A" through the seat openings on top. Pull the strap through the metal buckle. The seat will tighten automatically. The tighter the strap the more upright the seat will be. Prefer your seat in a more lying position? Then loosen the strap and make sure to tighten the strap below. More info at section "vastmaken onderkant"

To release the seat press the lever on the metal buckle. You may remove the seat now.

## gordels vastmaken aan bak

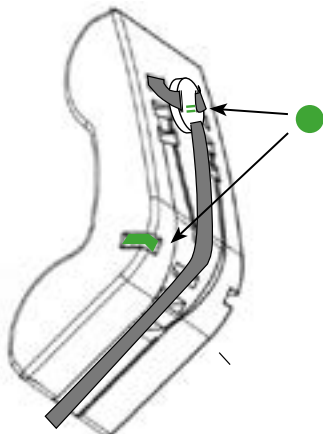

U had de MELIA stoel 5 punts reeds voorzien van de veiligheids 5 puntsgordel. **Focus aub alleen op de groen gekleurde vlakken in dit hoofdstuk.** Om het voor u overzichtelijk te houden laten wij in de verdere uitleg de 5 puntsgordel uit de tekening. Het gaat nu alleen om het vastmaken van de gordels aan de Urban Arrow bak. **U hoeft de**



You already installed the 5-point safetybelts in your MELIA seat. **Please focus on the green area's only for this chapter** how to install the belts to the frame" For drawing purposes we will leave behind the 5 point safetybelt in our next drawings. **Do not uninstall the seat for the assembly ahead!**

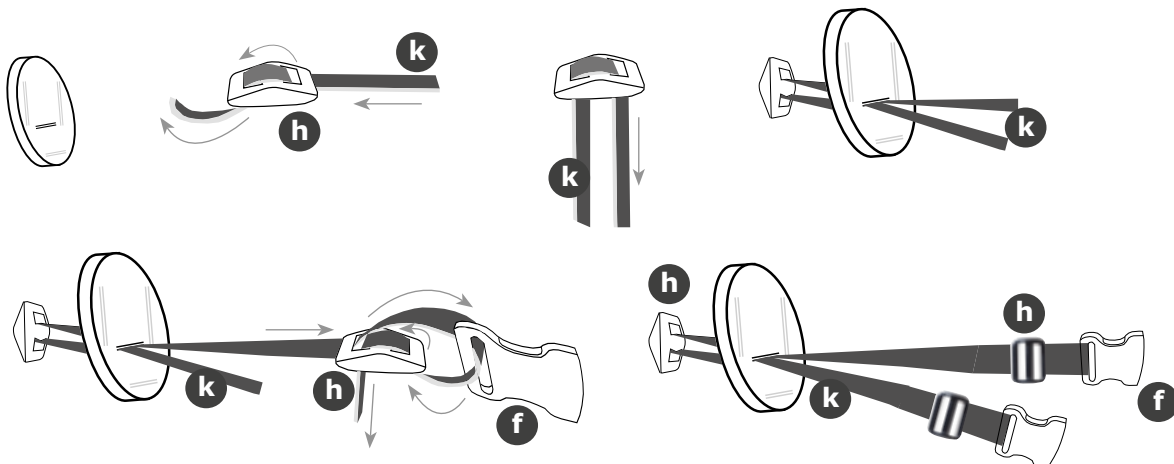

Volg bovenstaande voorbeelden. Gebruik onderdeel "H" en "F". Het ronde metalen plaatje zit reeds aan de achterkant van uw 5 punts MELIA stoel. U kunt deze gewoon erop laten. Bovenstaande montage kan ook terwijl het plaatje er op zit.



Follow the drawings as shown. The round metal plate is already installed by you. It may remain on the spot. The installation of above instructions can also be done while the metal plate is on its place.

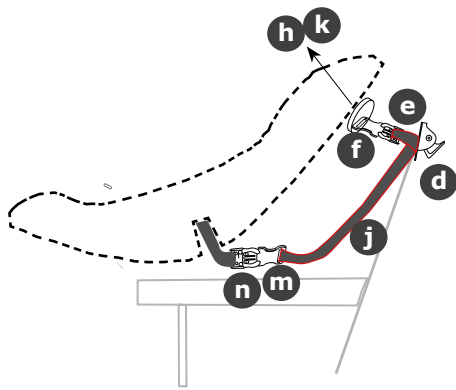
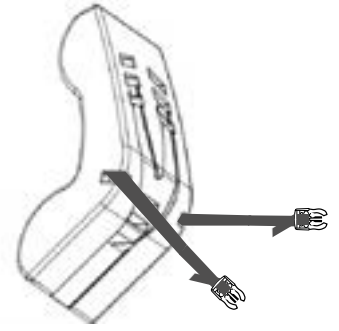
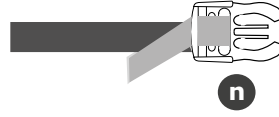
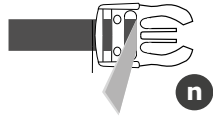
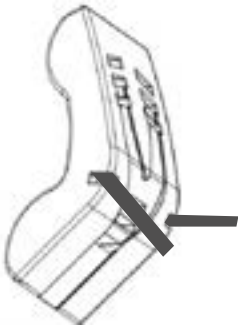

U had de 5 puntsgordel al gemonteerd. Uit de zijkanten van uw MELIA stoel komen dan twee bandjes van 40 mm. Volg bovenstaande tekening om onderdeel "N" te bevestigen aan het bandje. De tekening hiernaast toont wat uiteindelijk het resultaat is al alles vast zit.



You already installed the 5 point safety belt. From both sides a 40 mm strap will appear. Follow the above instructions using part "N".

if all done properly the drawing next will show the result.

## vastmaken onderkant

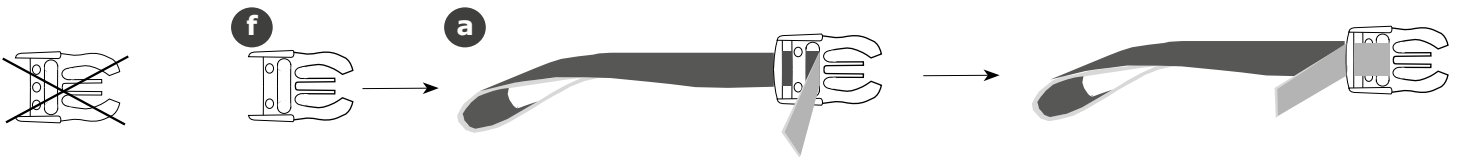

Ter voorbereiding moet u eerst onderdeel "A" en "F" samenvoegen tot één onderdeel. Zet steekgesp "deel 1" naar u toe en trek bandje "A" erdoor zoals te zien bij het voorbeeld. Als u het goed heeft gemonteerd dat kunt u het bandje er niet makkelijk meer uittrekken.



Before we start with mounting the parts in your cargobike you first have to put part "A" and "F" together. Place towards you as shown. Pull the strap "A" through the buckle. If all done properly it's not easy pulling the strap through the buckle.

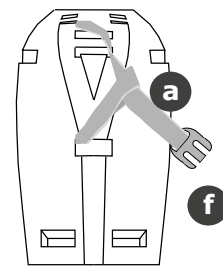
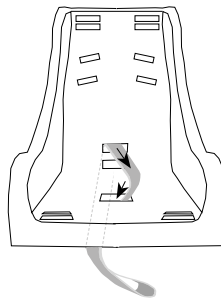
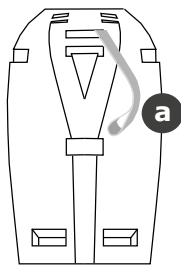

Nu het onderdeel gereed is gemaakt haalt u het bandje samen met de steekgesp door de middelste gaten van de MELIA stoel. De bedoeling is dat u het uiteinde van het bandje door de lus trekt, waardoor het bandje vast komt te zitten aan de onderkant van de stoel.



Now the part above is ready for use you may fix it onto the MELIA seat. Pull the strap with buckle through the mid holes of the set. Tighten it by pulling the end of the strap through the loop.

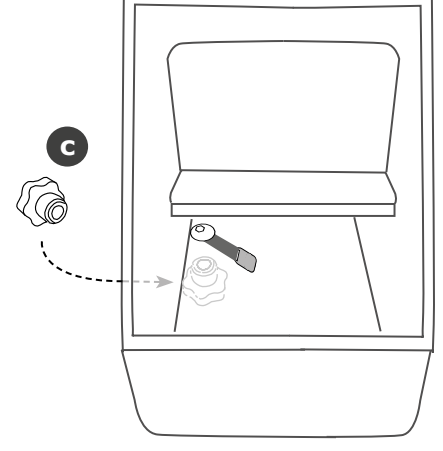
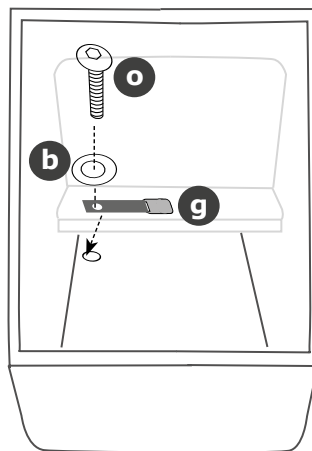
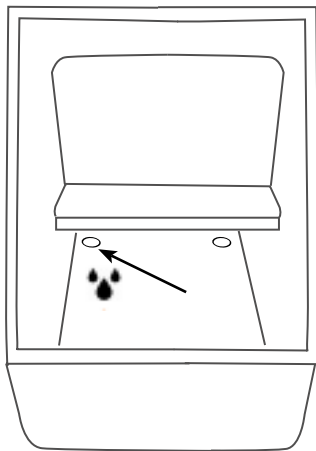
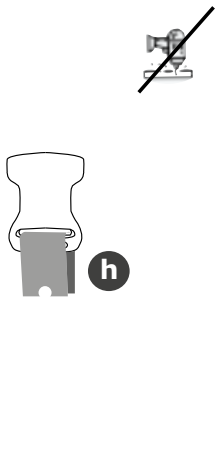

De meeste houten bakken hebben op de bodem afwateringsgaten. U kunt dit gebruiken om schroef "O" en onderdeel "G" te installeren. U hoeft daardoor geen extra gat te boren in de bodem. Pak onderdeel "G" en schroef vast. Gebruik draaiknop "C" en draai het vast onder de houtenbak



Your wooden chest of the cargobike has little holes in the corner of the bottom. It for the drainage of water. In that case no need to drill a hole. Just take part "E" and "H" en place the bolt through the hole. The bolt will stick out from underneath. Take knob "C" and tighten it underneath the bottom.

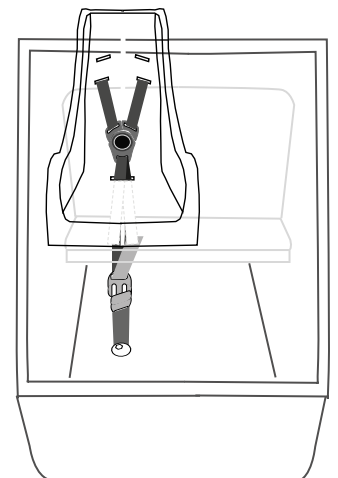
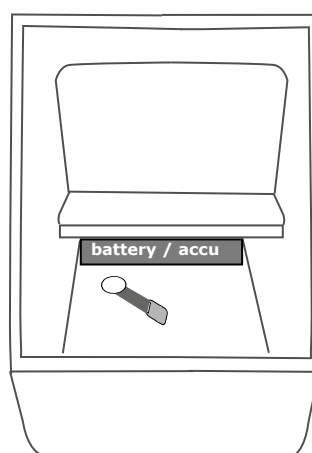
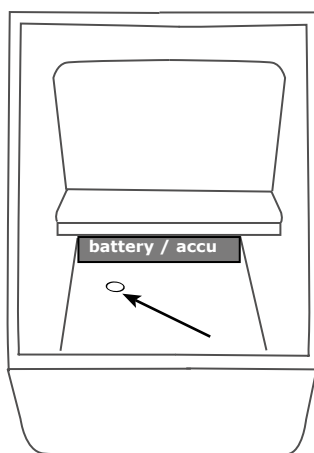

Heeft u onder uw bankje een accu? Dan dient u een gat te boren in de bodem van  $\varnothing$  6mm. Volg daarna de eerder gegeven instructies over hoe te bevestigen.



Do you have a battery under the bench? Make a hole in your wooden bottom of  $\varnothing$  6 mm. Then follow the instructions given earlier at the section above.

 [MELIA QUICK RELEASE MOUNTINGSET 5P UNI](#)



### Quick release mounting set 5 point by MELIA

Article# : A1001QGAT - 5  
EAN : 8718677872046  
Origing : Netherlands

 melia .nl

### MELIA bakfiets en fietskar accessoires

Kantoor Walenburgerweg 34  
3033 AC Rotterdam  
Netherlands

[www.melia.nl](http://www.melia.nl)  
[info@melia.nl](mailto:info@melia.nl)

+31 102654683 (office)

+31 636410065 (whatsapp)

Our warehouse and office are not at the same address. No visiting possibilities at the office please. We have no stock at the office

E-mails will be answered in 48 hours  
Whatapp message will be answered in 48 hours. In case of a matter that requires immediate attention, start your whatapp message with the words "urgent" and keep the message as short as possible.